

FLAT SURFACE

D12048

PROJECT _____

TYPE _____

NOTES _____

QUANTITY _____

DATE _____

GENERAL

Series: Flat
Division: Design
Mounting Type: Surface
Mounting Location: Ceiling
Subcategory: Ambient

PHYSICAL

Shape: Square
Length (mm): 298
Length (in): 11 3/4
Width (mm): 298
Width (in): 11 3/4
Height (mm): 80
Height (in): 3 1/8
Extension (mm): 80
Extension (in): 3 1/8
Light Distribution: Direct
Weight (kg): 2.26
Weight (lbs): 5
Diffuser: Opal White Satin Acrylic
Fixture Finish: WHI
Fixture Material: Metal

ELECTRICAL

Number of Lamps: 2
Lamp Type: LED Retrofit / CFL
Bulb Included: Bulb Not Included
Total Output Wattage (W): 20 / 36
Max. Wattage Per Lamp (W): 10 / 18
Lamp Base: 2G11
Driver Included: Yes
Driver Location: Integrated
Driver Type: Ballast - Universal
Input Voltage (V): 120 - 277
Lamp Voltage (V): 120

LED

OPTICAL

RATINGS AND CERTIFICATIONS

Certified By: CSA Certified to UL and CSA Standards
IP rating: IP20

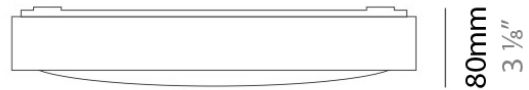

298mm 11 3/4"



FLAT SURFACE

D12050

PROJECT _____

TYPE _____

NOTES _____

QUANTITY _____

DATE _____

GENERAL

Series: Flat
Division: Design
Mounting Type: Surface
Mounting Location: Ceiling
Subcategory: Ambient

PHYSICAL

Shape: Square
Length (mm): 298
Length (in): 11 3/4
Width (mm): 298
Width (in): 11 3/4
Height (mm): 80
Height (in): 3 1/8
Extension (mm): 80
Extension (in): 3 1/8
Light Distribution: Direct
Weight (kg): 2.26
Weight (lbs): 5
Diffuser: Opal White Satin Acrylic
Fixture Finish: Chrome
Fixture Material: Metal

ELECTRICAL

Number of Lamps: 2
Lamp Type: LED Retrofit / CFL
Bulb Included: Bulb Not Included
Total Output Wattage (W): 26 / 36
Max. Wattage Per Lamp (W): 13 / 18
Lamp Base: 2G11
Driver Included: Yes
Driver Location: Integrated
Driver Type: Ballast - Universal
Input Voltage (V): 120 - 277
Lamp Voltage (V): 120

LED

OPTICAL

RATINGS AND CERTIFICATIONS

Certified By: CSA Certified to UL and CSA Standards
IP rating: IP20

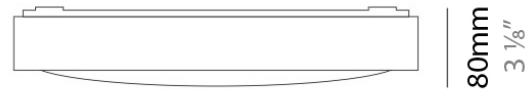

298mm 11 3/4"



FLAT SURFACE

D12060

PROJECT	_____
TYPE	_____
NOTES	_____
QUANTITY	_____
DATE	_____

GENERAL

Series: Flat
Division: Design
Mounting Type: Surface
Mounting Location: Ceiling
Subcategory: Ambient

PHYSICAL

Shape: Rectangle
Length (mm): 597
Length (in): 23 1/2
Width (mm): 222
Width (in): 8 3/4
Height (mm): 83
Height (in): 3 1/4
Extension (mm): 83
Extension (in): 3 1/4
Light Distribution: Direct
Weight (kg): 2.73
Weight (lbs): 6
Diffuser: Opal White Satin Acrylic
Fixture Finish: WHI
Fixture Material: Aluminum

ELECTRICAL

Number of Lamps: 2
Lamp Type: T5 Fluorescent
Bulb Included: Bulb Not Included
Total Output Wattage (W): 48
Max. Wattage Per Lamp (W): 24
Lamp Base: G5
Dimming: Phase Dimming (120Vac Only)
Driver Included: Yes
Driver Location: Integrated
Driver Type: Ballast - Universal
Input Voltage (V): 120 - 277
Upon Request: (Not included - see components) Integral: Phase dimming / Lutron

LED

OPTICAL

RATINGS AND CERTIFICATIONS

Certified By: CSA Certified to UL and CSA Standards
IP rating: IP20

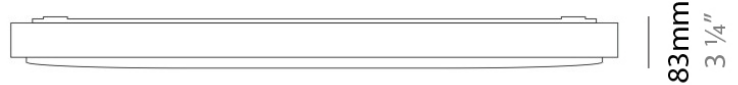
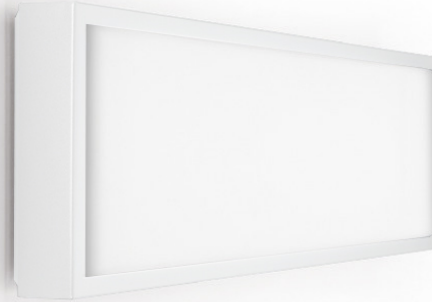

597mm 23 1/2"



FLAT SURFACE

D12061

GENERAL

Series: Flat
Division: Design
Mounting Type: Surface
Mounting Location: Ceiling
Subcategory: Ambient

PHYSICAL

Shape: Rectangle
Length (mm): 597
Length (in): 23 1/2
Width (mm): 222
Width (in): 8 3/4
Height (mm): 83
Height (in): 3 1/4
Extension (mm): 83
Extension (in): 3 1/4
Weight (kg): 2.73
Weight (lbs): 6
Diffuser: Opal White Satin Acrylic
Fixture Finish: NIC
Fixture Material: Metal

ELECTRICAL

Number of Lamps: 2
Lamp Type: T5 Fluorescent
Bulb Included: Bulb Not Included
Total Output Wattage (W): 48
Max. Wattage Per Lamp (W): 24
Lamp Base: G5
Dimming: Phase Dimming (120Vac Only)
Driver Included: Yes
Driver Location: Integrated
Driver Type: Ballast - Universal
Input Voltage (V): 120 - 277
Upon Request: (Not included - see components) Integral: Phase dimming / Lutron

LED

OPTICAL

RATINGS AND CERTIFICATIONS

Certified By: CSA Certified to UL and CSA Standards
IP rating: IP20

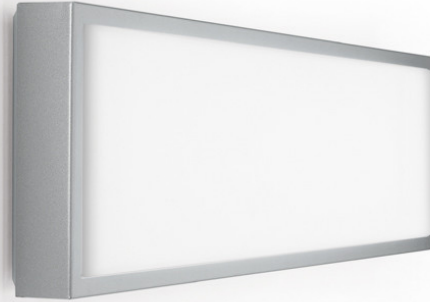

83mm
3 1/4"



222mm
8 3/4"

597mm 23 1/2"



PROJECT	
TYPE	
NOTES	
QUANTITY	
DATE	

FLAT SUSPENSION

D81429-WHI

GENERAL

Series: Flat
 Brand: Panzeri
 Division: Design
 Mounting Type: Suspension
 Mounting Location: Ceiling
 Subcategory: Ambient

PHYSICAL

Shape: Square
 Length (mm): 510
 Length (in): 20 ¹/₁₆"
 Width (mm): 510
 Width (in): 20 ¹/₁₆"
 Height (mm): 45
 Height (in): 1 ³/₄"
 Max. Overall Height (mm): 2510
 Max. Overall Height (in): 98 ¹³/₁₆"
 Light Distribution: Direct / Indirect
 Weight (kg): 7.21
 Weight (lbs): 15.89
 Diffuser: White Blown Glass
 Fixture Material: Metal

ELECTRICAL

Lamp Type: LED
 Input Wattage (W): 61
 Total Output Wattage (W): 57.5
 Max. Wattage Per Lamp (W): 46 / 11.5
 Dimming: Tri-Mode (Non-Dimming and Phase Dimming (120Vac only) and 0-10V Dimming)
 Driver Included: Yes
 Driver Location: Integrated
 Driver Type: Constant Current - Universal
 Driver Class: Class 2
 Input Voltage (V): 120 - 277
 Constant Current (mA): 700

LED

Color Temperature (°K): 3000
 Max. Delivered Lumen (lm): 4077
 Nominal Lumen (lm): 4800lm down+1200lm up
 CRI: >80 CRI
 Lamp Life (hrs): 60000

OPTICAL

RATINGS AND CERTIFICATIONS

Certified By: CSA Certified to UL and CSA Standards
 IP rating: IP40

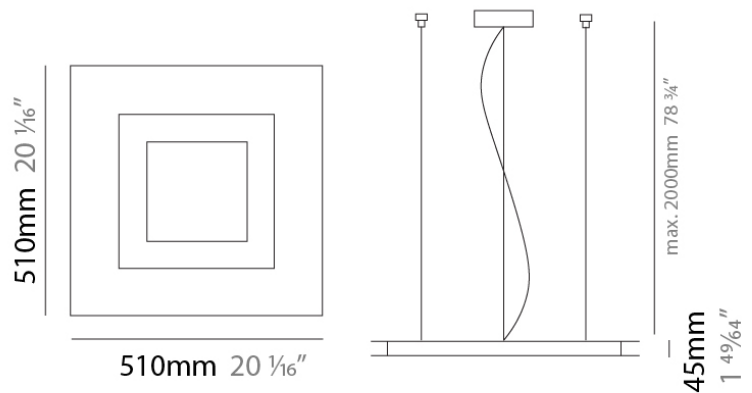

PROJECT	_____
TYPE	_____
NOTES	_____
QUANTITY	_____
DATE	_____

FLAT SURFACE

D82230-WHI

GENERAL

Series: Flat
Brand: Panzeri
Division: Design
Mounting Type: Surface
Mounting Location: Ceiling
Subcategory: Ambient

PHYSICAL

Shape: Square
Length (mm): 510
Length (in): 20 1/16
Width (mm): 510
Width (in): 20 1/16
Height (mm): 45
Height (in): 1 3/4
Light Distribution: Direct / Indirect
Weight (kg): 5.236
Weight (lbs): 11.54
Diffuser: Polycarbonate - Opal
Fixture Material: Metal

ELECTRICAL

Input Wattage Range: 30 - 49 W
Lamp Type: LED
Input Wattage (W): 48
Total Output Wattage (W): 46
Dimming: Non-Dimming / Phase Dimming (120Vac only) / 0-10V Dimming
Driver Included: Yes
Driver Location: Integrated
Driver Type: Constant Current - Universal
Driver Class: Class 2
Input Voltage (V): 120 - 277
Constant Current (mA): 350

LED

Color Temperature (°K): 3000
Max. Delivered Lumen (lm): 3202
Nominal Lumen (lm): 5700
CRI: >80 CRI
Efficiency (%): 56.175%
Lamp Life (hrs): 70000

OPTICAL

RATINGS AND CERTIFICATIONS

Certified By: CSA Certified to UL and CSA Standards
IP rating: IP40

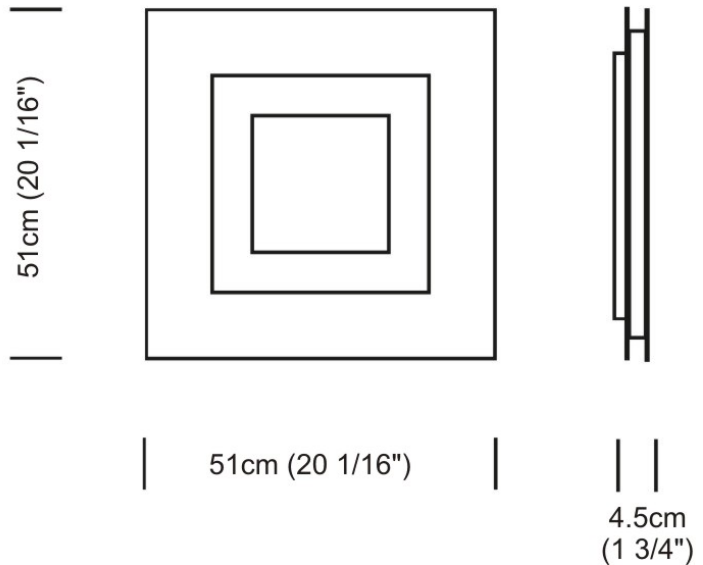











LEGEND

	floor-mounted		pivotal		special LED (upon request) RGB, RGBW, tunable, gold+, meat+, art+, fashion+
	wall and ceiling: recessed and surface mounted		rotating		warm dim / natural dimming LED
	ceiling-mounted and wall-mounted		illuminate tilted		rechargeable battery powered
	wall-mounted		color of suspension cable		fixture with natural vivid LED (upon request)
	omni-directional light distribution		length of suspension cable		color rendering index
	direct light distribution		reflector degree selection		color temperature
	direct/indirect light distribution		super spot		lumen (luminous flux)
	indirect light distribution		lens		efficacy (lumens per watt)
	asymmetric light distribution		lens pack		Unified Glare Rating (UGR) range from 5-40
	aura light distribution		shine ring		marine grade (AISI 316 stainless steel)
	round wall or ceiling cut-out		integrated shine ring with diffuser		walk on
	square wall or ceiling cut-out		free individual colors 01-29		drive on
	the supplied jig specifies the cutout dimensions		individual colors: 00 (free of charge), 01-25 (extra charge)		Dark Sky Compliance
	minimum distance (meters) lamp - object		luminaire part to be colored (F1)		Americans with Disabilities Act (less than 4" off the wall located between 27"-84" from floor)
	recessed depth		luminaire part to be colored (F2)		lamp protected against explosion
	ceiling thickness in mm		luminaire part to be colored (F3)		blown glass using traditional methods by master glass blower
	ceiling thickness selection		luminaire part to be colored (F4)		acoustic material
	dimmable DP (phase), DV (0-10V), DD (dali), DS (step-dim)		luminaire part to be colored (F5)		protection class I, protection insulation
	included or excluded LED driver/transformer/control gear		color of 3-circuit adaptor		protection class II, protection insulation
	separately switchable		indirect diffuser		ETL Certified to UL and CSA Standards
	sensor		direct diffuser		UL Certified to UL and CSA Standards
	remote control		ball-proof (upon request)		CSA Certified to UL and CSA Standards
	available upon request		accessory		Certified for North American Standards

IP RATING

	protected against ingress of solid bodies greater than 12.5mm (finger)
	protected against ingress of solid bodies greater than 2.5mm protected against sprays of water up to 60 degrees from the vertical (rain)
	protected against ingress of solid bodies greater than 1mm (wire) no protection against the ingress of moisture
	protected against ingress of solid bodies greater than 1mm (wire) protected against sprays of water up to 60 degrees from the vertical (rain)
	protected against ingress of solid bodies greater than 1mm (wire) protected against water splashed from all directions
	protected against limited ingress of dust (wet rooms/covered outdoor areas) protected against water splashed from all directions
	protected against ingress of dust protected against jets of water
	protected against ingress of dust protected against powerful jets of water or heavy seas
	protected against ingress of dust protected against immersion of water between 15cm - 1m for 30 minutes
	protected against ingress of dust protected against immersion of water under pressure for long periods

IK RATING

	protected against 0.14 joules impact (equivalent to 0.25kg mass dropped from 56mm above the surface)
	protected against 0.2 joules impact (equivalent to 0.25kg mass dropped from 80mm above the surface)
	protected against 0.35 joules impact (equivalent to 0.25kg mass dropped from 140mm above the surface)
	protected against 0.5 joules impact (equivalent to 0.25kg mass dropped from 200mm above the surface)
	protected against 0.7 joules impact (equivalent to 0.25kg mass dropped from 280mm above the surface)
	protected against 1 joules impact (equivalent to 0.25kg mass dropped from 400mm above the surface)
	protected against 2 joules impact (equivalent to 0.5kg mass dropped from 400mm above the surface)
	protected against 5 joules impact (equivalent to 1.7kg mass dropped from 300mm above the surface)
	protected against 10 joules impact (equivalent to 5.0kg mass dropped from 200mm above the surface)
	protected against 20 joules impact (equivalent to 5.0kg mass dropped from 400mm above the surface)